

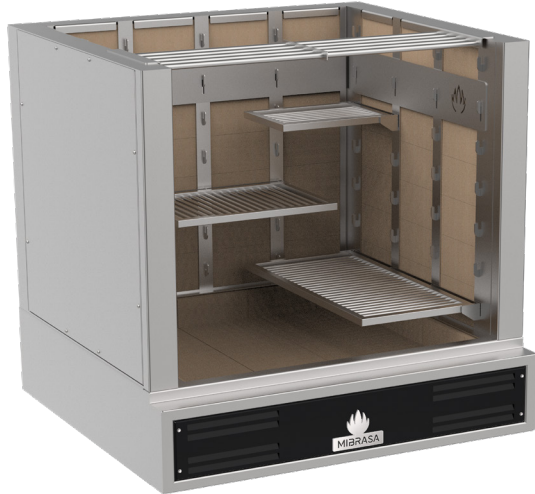

CUSTOM S

Mibrasa® Parrilla Custom with refractory brick wall



FEATURES

FULLY CUSTOMIZABLE MADE-TO-MEASURE
OPEN-FIRE GRILLING

Based on a personalized and functional design for optimal utilization, your Mibrasa® Parrilla CUSTOM will be designed and built to your specifications to optimize your kitchen space.

The hearth and wall lined with refractory bricks is designed to harness heat energy for maximum efficiency. Combine charcoal and firewood for a high performing grill, and enhance your cooking experience to deliver flame-kissed food like no other.

The versatile wall grid system lets you effortlessly hook, place and freely rearrange multiple grids in any position you need along the side and back walls.

TECHNICAL INFORMATION

Reference	CUSTOM S
Fire up time*	30 min
Cooking temperature*	250 °C
Initial charcoal load ¹	12 kg
Charcoal load duration ²	5 h
Equivalent power ²	4.8 kW
Exhaust rate ²	4300 m ³ /h
Net weight ³	453 kg
Crate dimensions ³	1300 x 1100 x 1340 mm

1. Maximum recommended load
 2. Based on data from point 1
 3. Weight with accessories included
- *Approximate data

INCLUDED ACCESSORIES

- 1 small grid [CPS-25]
- 1 medium grid [CPS-48]
- 1 large grid [CPS-70]
- Vertical cooking support [CPH-CMB-108]
- 2 swivel hooks [GGCV]
- Mibrasa tongs [TG]
- Ash shovel [PALA L]
- Ember poker [PK]
- Grill brush [CEP]

OPTIONAL ACCESSORIES

- Extra small, medium and large grids [CPS-25/48/70]
- Multi-cooking support [BMC]
- Paella stand [PMB-1/2/3]
- Coup de feu [COUPDEFEU]
- Irori [IRORI40/60]
- Estaca grill stake [ESTACA]
- Open fire basket [QACMB]
- Closed fire basket [QCCMB]
- Stand [MACMB-S]
- Complete stand [MCCMB-S]
- Wheel out storage stand [MBCMB-S]
- Casters [WINOX]

Color



Edition



QUALITY GUARANTEE



Rev. 1/26

Mibrasa® Charcoal Ovens S.L
C/Joan Rovira i Bastons, 26
17230 Palamós - Spain
+34 972 601 942 - mibrasa@mibrasa.com
www.mibrasa.com

Front view

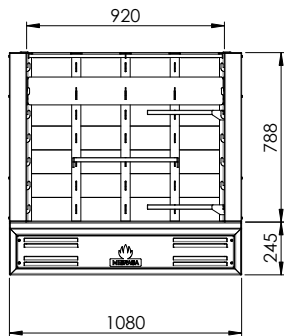

Side view

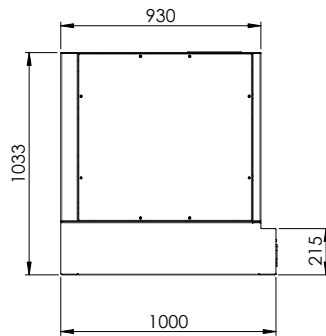

Top view

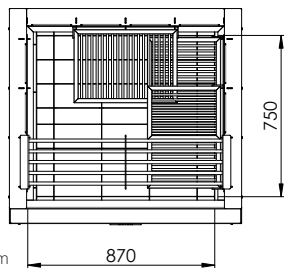

Dimensions in mm

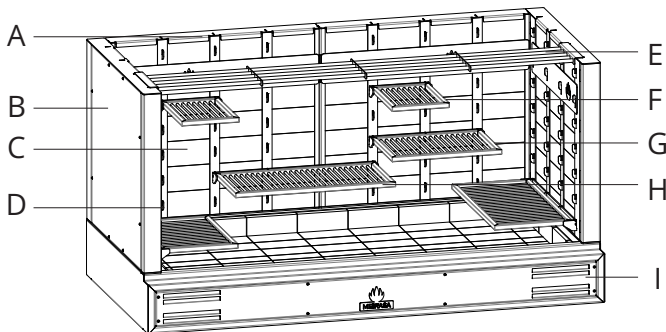

A	Insulated refractory back wall
B	Insulated refractory side wall
C	Refractory bricks
D	Fixed grid hooks
E	Vertical cooking rack
F	Small grid
G	Medium grid
H	Large grid
I	Body

GRILL DIMENSIONS

Small grid [CPS-25]

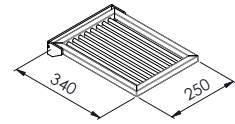

Medium grid [CPS-48]

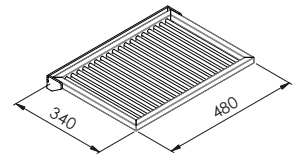

Large grid [CPS-70]

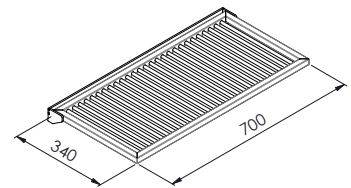

VERTICAL COOKING RACK DIMENSIONS

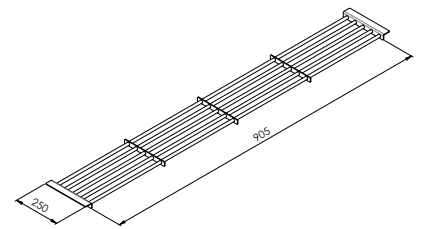

INSTALLATION GUIDELINES AND SAFETY STANDARDS

Recommended installation height	700 mm
Clearances to construction/other appliances from the Parrilla Custom	76 mm
Clearances of flammable materials from the Parrilla Custom	300 mm
Clearance of workspace from front of the Parrilla Custom	700 mm



It is recommended to use a lifting device to lift the Parrilla Custom and place on the countertop stand. Consult Parrilla Custom instruction manual for further information.

Specifications and design are subject to change without notice.

OPTIONAL STAND



TECHNICAL INFORMATION

Reference	CUSTOM S + CMB-S MA
Net weight	502.8 kg
Crate dimensions	1300 x 1100 x 1900 mm

Reference	CMB-S MA
Net weight	49.8 kg

OPTIONAL ACCESSORIES

- Stainless steel casters [WINOXG]

Dimensions in mm

FRONT VIEW

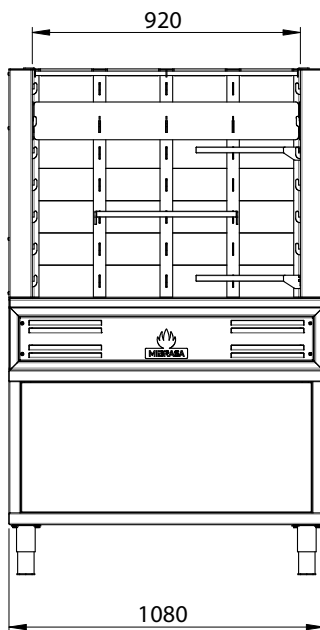

SIDE VIEW

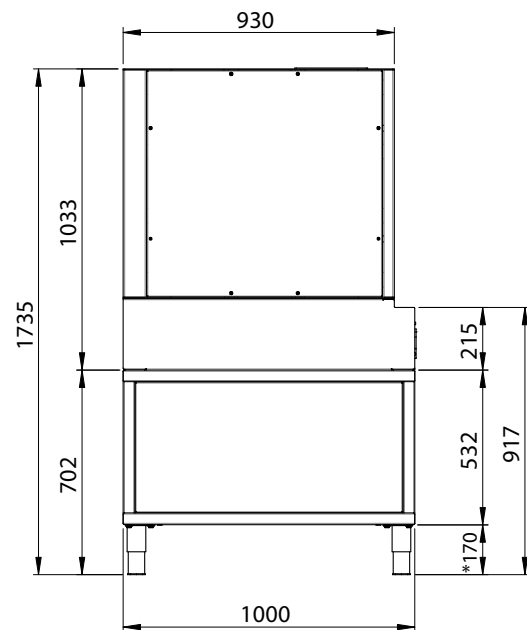

*Adjustable leg height 135-195 mm

OPTIONAL COMPLETE STAND



TECHNICAL INFORMATION

Reference	CUSTOM S + CMB-S MC
Net weight	595.4 kg
Crate dimensions	1300 x 1100 x 1900 mm

Reference	CMB-S MC
Net weight	142.4 kg

OPTIONAL ACCESSORIES

- Stainless steel casters [WINOXG]

Dimensions in mm

FRONT VIEW

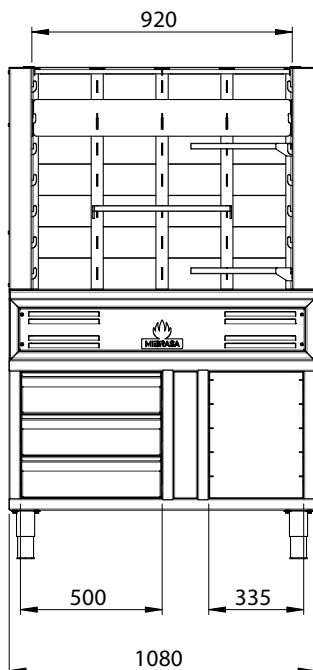

SIDE VIEW

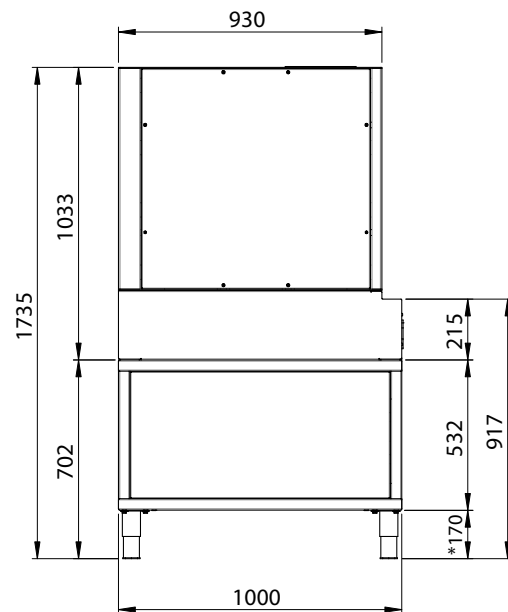

*Adjustable leg height 135-195 mm

OPTIONAL STAND WITH WHEEL OUT STORAGE



TECHNICAL INFORMATION

Reference	CUSTOM S + CMB-S MB
Net weight	548.3 kg
Crate dimensions	1300 x 1100 x 1900 mm

Reference	CMB-S MB
Net weight	95.3 kg

OPTIONAL ACCESSORIES

- Stainless steel casters [WINOXG]

Dimensions in mm

FRONT VIEW

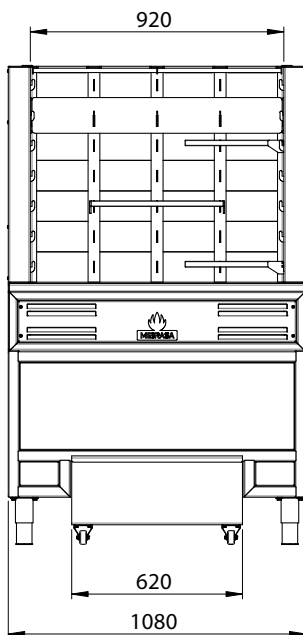

SIDE VIEW

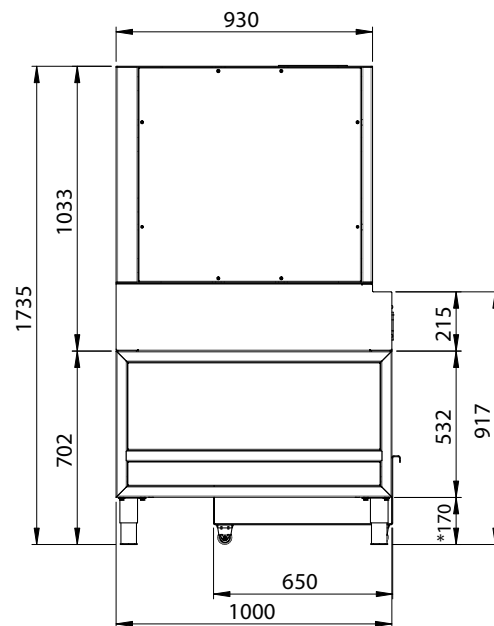

*Adjustable leg height 135-195 mm