

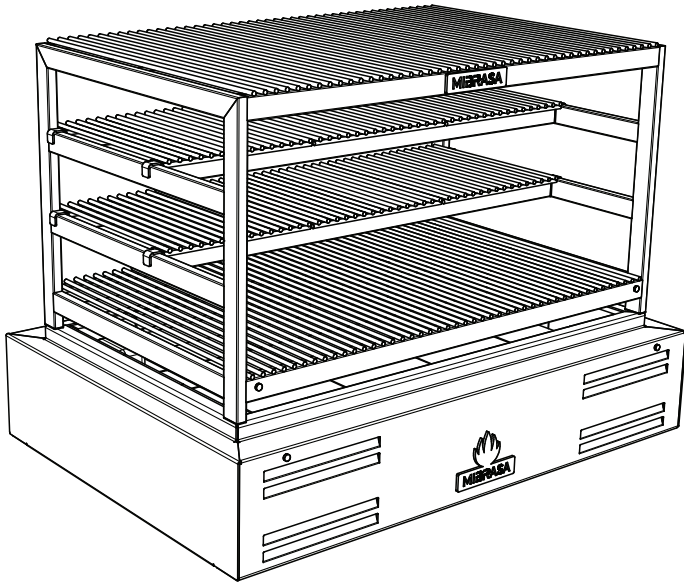

MIBRASA® ROBATA BEAST USER MANUAL



Read all instructions before installing and using the appliance.
Save these instructions.

The Craftsmen of Fire!

www.mibrasa.com

Mibrasa, The Craftsmen of Fire!



We are fascinated by fire and invite you to experience grill cooking for yourselves. Cook and create in a way that awakens your taste buds and remind us of the beauty in simplicity.

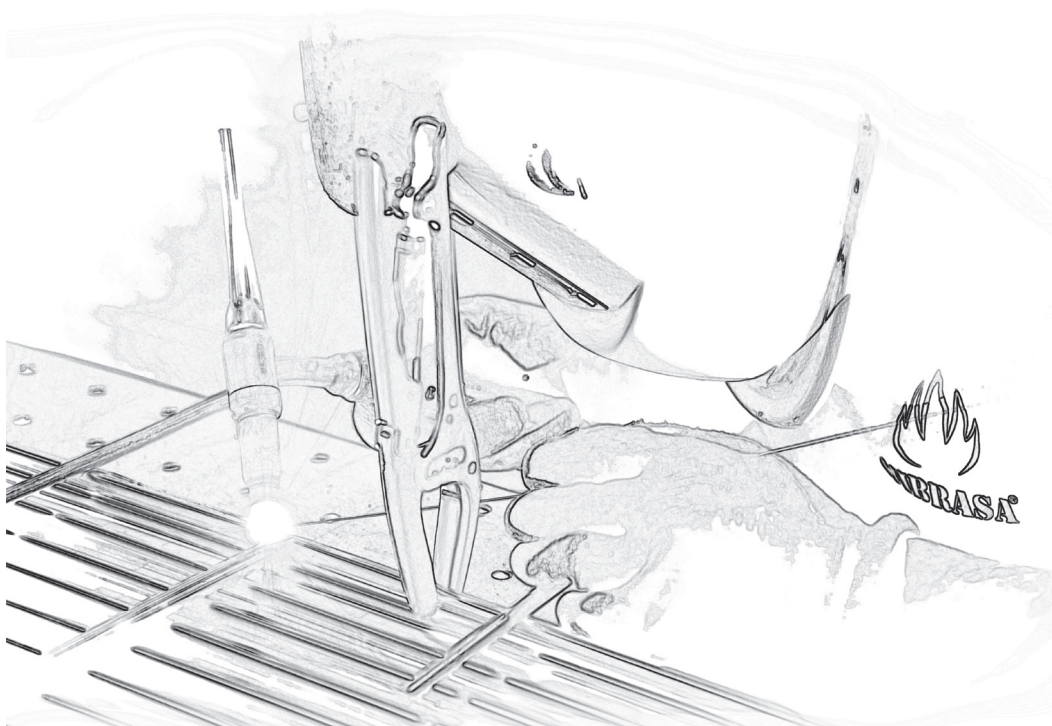

Contents

1. Introduction	1
2. Safety standards and dangers	2
3. Mibrasa® RM Beast dimensions	3
4. Parts of the Mibrasa® RM Beast	5
5. Installation instructions	7
5.1. Installation guidelines and safety standards	
6. Lighting up	8
7. Maintenance and safety standards	9
7.1 Daily cleaning	
7.2 Special care	
8. General conditions	10
8.1 Warranty	
8.2 Returns	
8.3 Property Reserve	

1. Introduction

The Mibrasa® Robata Beast is conceptualized and engineered for chefs in need of high production and versatility.

Experiment with levels, temperatures and position of the grills to apply infinite cooking techniques at the same time. It lets us sear, cook and rest our ingredients, achieving the optimal result every time.

The Mibrasa® Robata Beast is manufactured with steels of the latest technology following the most rigorous quality controls. Like all Mibrasa® units, they comply to the strict standards & regulations set by internationally recognized certifications of quality.



Our Robata Beast

Equipped with 4 fixed levels, each of which offers extense, adaptable and removable cooking surfaces that allow you to cook multiple ingredients.

Execute varied cooking techniques from direct, vertical, skewer and spit-roast, among others to suit all types of gastronomy.

Guarantee maximum heat efficiency and a higher burning capacity of charcoal or firewood thanks to the base pit lined with refractory bricks.

Please read this entire manual before you install the Mibrasa® Robata Beast.
Failure to follow instructions may result in property damage, bodily injury, or even death.

2. Safety standards

- Only use charcoal in the Mibrasa® Robata Beast
- The first time the Mibrasa® Robata Beast is used do not cook food for at least one hour after lighting.
- Proceed with reasonable care when operating a Mibrasa® Robata Beast. Never leave it unattended when lit.
- **CAUTION** Do not overload/fire. Consult the charcoal loads in the chart in point 6
- Disposal of ashes – Ashes should be placed in a metal container with a tight-fitting lid. The closed container of ashes should be placed on a non-combustible floor or on the ground, well away from all combustible materials, pending final disposal. When the ashes are disposed by burial in soil or otherwise locally dispersed, they should be retained in the closed container until all cinders have thoroughly cooled.
- Do not attempt to pour water over the hot coals.
- Do not clean the Mibrasa® Robata Beast when it is in operation or hot.
- Do not use chemical products to clean the exterior of the Mibrasa® Robata Beast when in use or hot.

DANGERS

- If the Mibrasa® Robata Beast is not correctly installed, a fire may result. To reduce the risk of fire, follow the installation instructions.
- Keep children and pets away from the oven and flammable products. Accessible parts of the Mibrasa® Robata Beast may be very hot.
- Do not use alcohol, oil or other liquids similar to ignite or rekindle hot coals. Use only Mibrasa® ecofire firelighters.
- In the case of installing the Mibrasa® Robata Beast in an outdoor setting, do not cover it with any type of protective cover or inflammable material when it is in operation or hot.
- Read the restrictions in point 5.1 on minimum distances from combustible materials.

3. Mibrasa Robata Beast dimensions

RM 100 BEAST

Dimensions in mm

FRONT VIEW

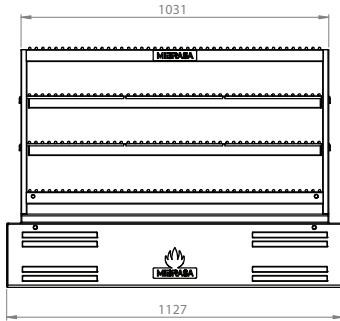

SIDE VIEW

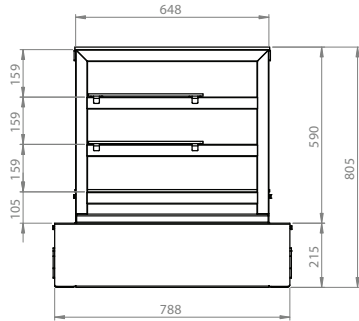

TOP VIEW

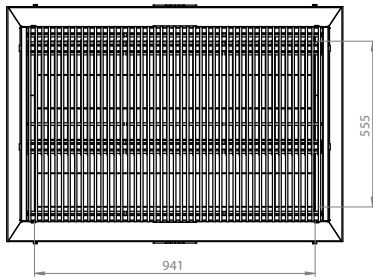

Size of useful surface area of top and lower grills

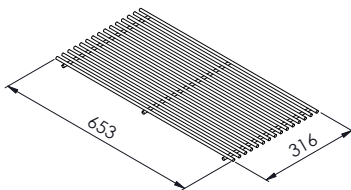

Size of useful surface area of middle grills

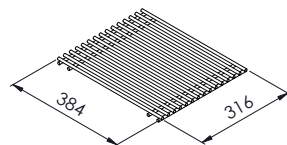

RM 100 BEAST with complete stand (MCGMB100)

Dimensions in mm

FRONT VIEW

SIDE VIEW

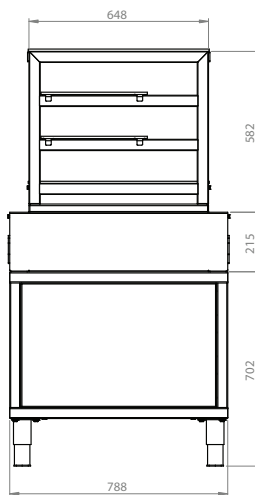
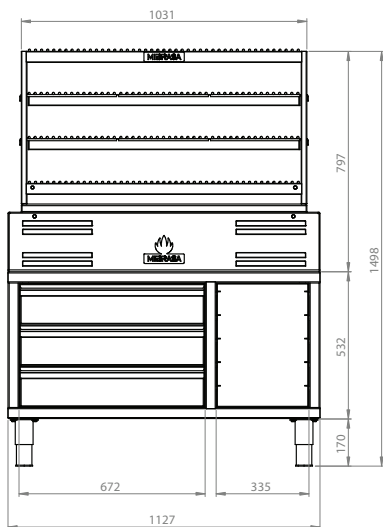

RM 100 BEAST with stand (MGMB100)

FRONT VIEW

SIDE VIEW

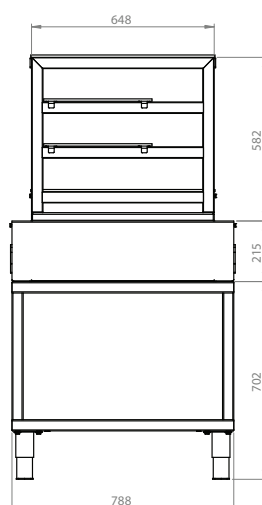
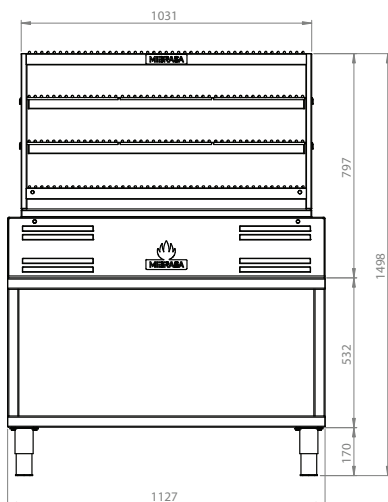

The Mibrasa® Robata Beast is subject to technical and design changes.

4. Parts of the Mibrasa® Robata Beast

1. Structure

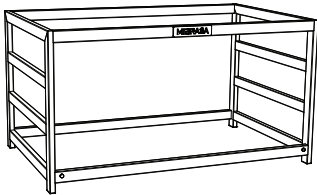

2. Burning pit base

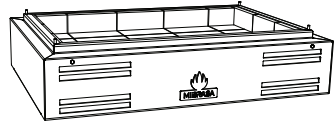

3. Support bars



4. Refractory bricks

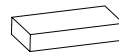

5. Top and lower grill

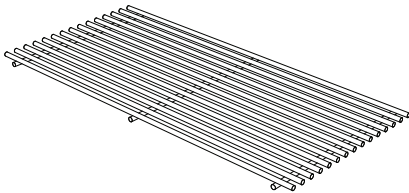

6. Middle grill

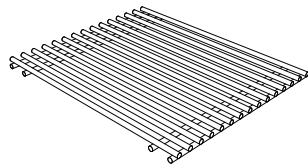

Included accessories

Top and Lower grills (x6)

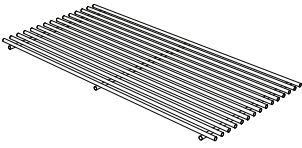

Middle grills (x6)

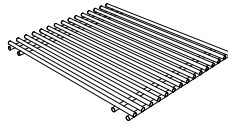

Mibrasa tongs

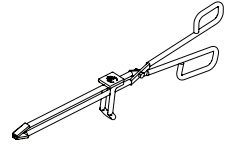

Ash shovel

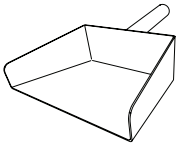

Ember poker

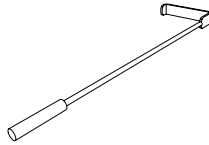

Grill brush

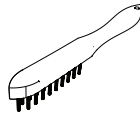

Mibrasa Ecofire firelighters

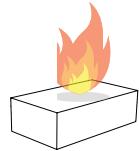

Optional accessories

Top and lower grill

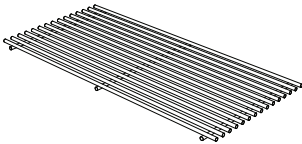

Middle grills

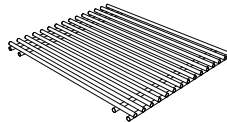

Stand/Complete stand

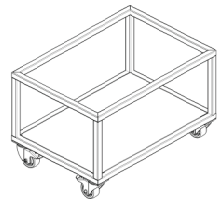

S/S lid

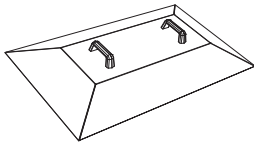

Spit-roast

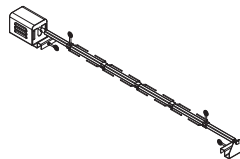

Kitchenware & Grillware



(consult our catalogue
at www.mibrasa.com)

5. Installation instructions

1 Remove grills and support bars

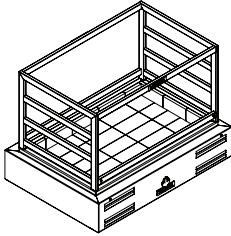

2 Lift and remove structure

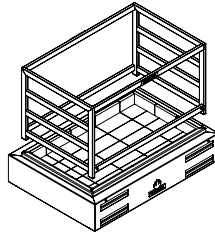

3 Place main body on top of work table or stand

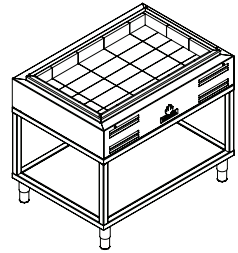

4 Replace structure

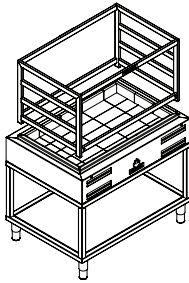

5 Replace grills and support bars

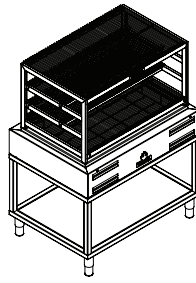

6 Ready to cook

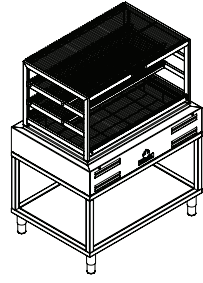

5.1 Installation and safety standards

The installer should contact the local building or fire officials concerning any installation restrictions or need for inspection of the Mibrasa® Robata Beast installation.

- Do not place combustible materials within a distance of 300mm from the bottom, rear or side of the Mibrasa® Robata Beast.
- Clearances to construction/other appliances from unit back and sidewalls: 76mm.

Workspace for the chef and recommended worktop height.

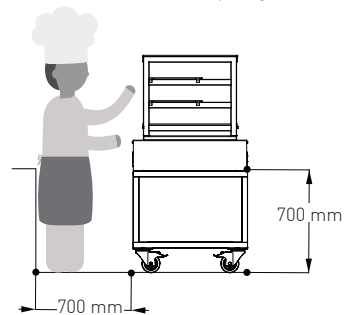

Ventilation recommendations

Model	Flow rate (m ³ /h)	Hood dimensions (Width x depth in mm)	Minimum height of hood from floor (mm)
RM 100	4100	1500 x 1300	2000

6. Lighting up

1 Remove grills and load charcoal

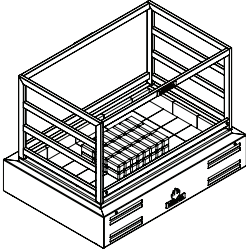

2 Place and light Ecofire firelighters

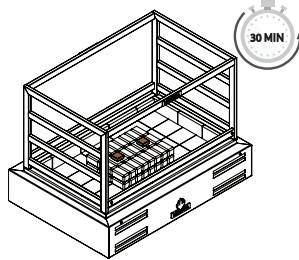

3 Spread embers

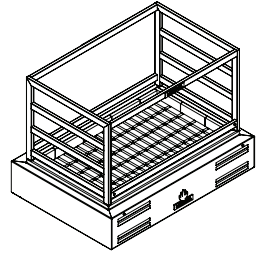

Always light the charcoal inside the refractory-lined hearth

5 Replace grills

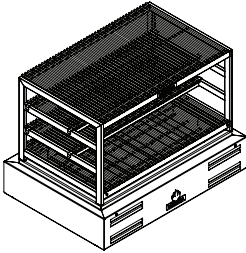

6 Ready to cook

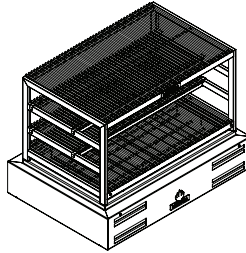

Approximate quantity of charcoal according to Robata Beast model:

Model	Initial charcoal load
RM 100	10 Kg

7. Maintenance and safety standards

7.1. Daily cleaning

Do not use chemical products or water to clean the inside of the Mibrasa® Robata Beast.

Grills: clean using the grill brush before and after each use.

Ash extraction: use the ash shovel to remove the ash. Once the ashes have completely cooled down they can be used as fertilizer.

WARNING Do not dispose ashes in a flammable-container or heat-deformable container.

7.2. Special care

Exhaust hood and ductwork: it is very important to keep the exhaust hood filters clean as well as the interior and ducts to avoid a build up of soot and fat, which could result in a possible fire.

Follow the weekly cleaning procedures and annual maintenance of the hood, ventilation box and flue ducts in accordance to the exhaust hood manufacturer's requirements. Water mist filtration systems are also accepted to compliment the use of this Mibrasa® Robata Beast. The ductwork should be inspected at least twice a year to determine when creosote build up has occurred.

Mibrasa® is not responsible for any damages occurred caused by wrongful use, when the installation instructions have not been followed or wrongful maintenance of the exhaust hood.

8. General conditions

8.1. Warranty

- All Mibrasa® Robata Beasts have a 2-year warranty against any manufacturing defect.
- The customer will be responsible for the installation, fine-tuning and maintenance of the goods.
- The warranty is void of:
 - (I) damage caused by misuse or poor product installation,
 - (II) where the buyer or third party has started repairs, modifications or adjustments without the prior consent of Mibrasa®.
 - (III) those defects not immediately notified within the warranty period stated above,
 - (IV) those defects or damage due to negligence not attributable to Mibrasa®, or an accident, misuse, improper installation, mishandling or abnormal conditions of temperature, humidity or dirt.
 - (V) that have become damaged through no fault of Mibrasa®.

8.2. Returns

- All goods must be returned in the original condition.
- All returns must be notified in writing and must be confirmed by our sales department.
- All returns must reach Mibrasa® prepaid. Returned material must enclose the invoice and delivery note number.
- Returns of goods will only be accepted in its original packaging, unused and in re-sellable condition. Returned goods that are used, obsolete or worn out will not be considered under warranty and a credit note will not be issued.
- For all returned goods, there will be a 10% fee of the refund amount to cover depreciation, demerit and administrative tasks.

8.3. Property Reserve

- Mibrasa® retains title to the goods to the total amount of the price integrity.
- Mibrasa® reserves the right to change their products and prices without notice.

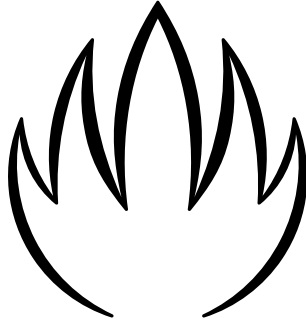

MIBRASA®

The Craftsmen of Fire!

Factory, head office and showroom:

Polígon Pla de Sant Joan
C/ Joan Rovira i Bastons, 26
17230 Palamós (Girona)
Spain

+34 972 601 942
www.mibrasa.com
mibrasa@mibrasa.com

v.10.22